

COMPACT

FIRST ELECTRIC ACTUATORS EMV 110

with Flexible holder and Clip system for 2-way and 3-way valves

FIRST®

2-POINT CONTROL	1 / 0	STOP AT END POSITIONS
-----------------	-------	-----------------------



FIRST actuators EMV 110, series COMPACT, are 2-point control actuators designed for operating 2-way and 3-way valves with flexible holder system and clip system (DN 15 - DN 32).

- The FIRST COMPACT actuators have not defined (ND) direction of rotation 90°/360°.
- Actuators are available with cable connection.
- Recommended for on/off and diverting applications.

OPERATION

COMPACT is an electric actuator designed for operating 2-way and 3-way valves. Actuators are controlled by 2-point SPST signal built-in relay module. FIRST COMPACT actuators allow high regulating accuracy and easy installation with one-click CLIP system or flexible holder system.

Actuators are available in 230V AC 50 Hz / 24V AC 50 Hz and are supplied with a 1,5m attached connection cable. Actuator can be manually operated (4230). COMPACT actuators are recommended for on/off applications. Actuators 4230 with FBV 200C (DN15 - DN32), and actuators 4930 with FBV 600 valves (DN 15- DN 32). Compact actuators can also be used for diverting applications. Actuators 4950 with FBV 230C-L valves.

Anti blocking function provides that in case of blockade the motor changes its direction. Because of that feature, the motor is able to save itself from stopping.

MAINTENANCE

Actuator requires no maintenance. The installation of suitable strainer is recommended.

TECHNICAL DATA: ACTUATOR

Control:	2-point SPST
Supply voltage:	230 VAC 50Hz / 24 VAC 50Hz
Rotation time:	30s/90°, 60s/180°
Power consumption:	9 VA (operation), 5 VA (stand by relay on), 0 VA (stand by relay off)
Max. Torque:	8 Nm
Protection class:	II
Enclosure rating:	IP44
Connection:	cable 1,5 m, 4 x 0,5 mm ²
Direction of rotation:	ND, undefined CW/CCW (90°/360°; 180°/ 360°)
Manual control:	yes (with flexible holder system)
Position indicator:	with position indicator
Media temperature:	+2°C..+110°C (With optional SCA adaptor -15°C to +125°C, briefly up to +150°C)
Ambient temperature:	0°C..+55°C
Storage temperature:	-10°C..+70°C
Humidity:	0%..80% R.H. (non condensed)

INSTALLATION POSITION

Actuator can be installed only in one position.

4930 with FBV 200C valves for on/off applications.

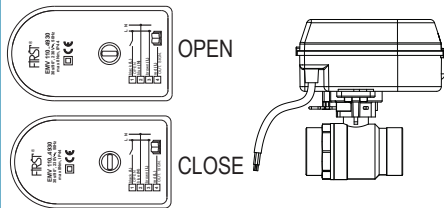

4950 with FBV 230C-L valves for diverting applications.

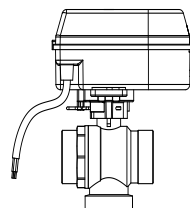

4230 with FBV 600 valves for on/off applications.

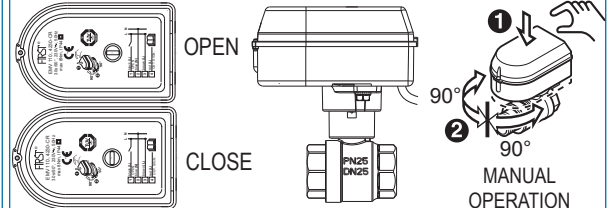

SUITABLE VALVES

FBV 200C



Available as zone unit:
Compact 200C

FBV 230C-L



ELECTRICAL CONNECTION

2- point control SPST:

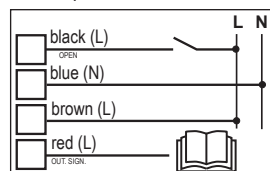

FBV 600



Available as zone unit: Compact 600

FLEXIBLE HOLDER SYSTEM

CLIP SYSTEM

Compact design of the valve allows easy assembling and disassembling. Clip system allows easy installation of the actuator on the valve body with single click, without any tools.



OR

ONE-CLICK CLIP SYSTEM

FLEXIBLE HOLDER SYSTEM

Flexible holder for valve allows manual operation of valve without handle and button and allows indication of position on the valve holder.



CE In accordance with PED, LVD, RoHS2, EMC

FIRST®

FIRST d.o.o.
Koroška cesta 56
SI-3320 Velenje
SLOVENIA

phone: +386 3 898 35 00
fax: +386 3 898 35 35
email: info@first.si
web: www.first.si

www.first.si
Let First be your first choice.



ACTUATORS

VALVES

HEATING CONTROLLERS

COMPACT

FIRST ELECTRIC ACTUATORS EMV 110

with Clip or Flexible holder system for 2-way valves

Actuator with Flexible holder system- 4230

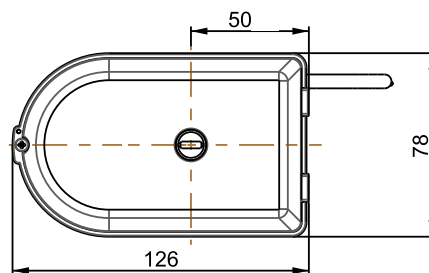
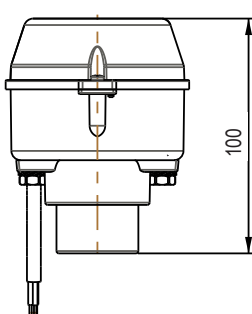
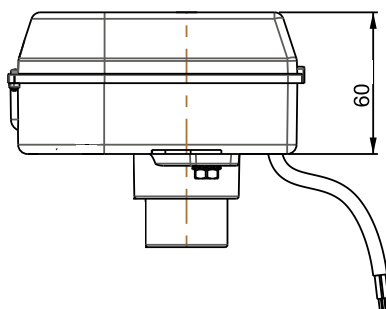

Actuator with Clip system- 4930 / 4950

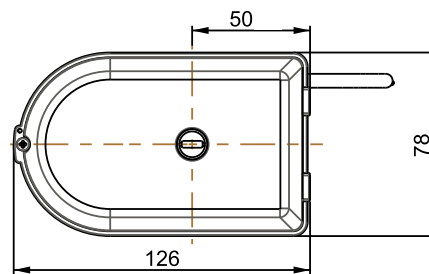
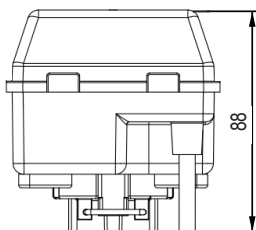
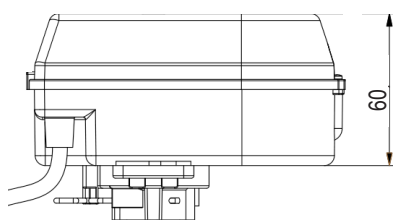

COMPACT, for 2-way and 3-way ball valves (90° rotation)

Code	Type	Voltage	Rotation time	Control signal	Connection	Max. torque [Nm]	Weight [kg]	Price (€)
20119	4230-K	230 VAC 50 Hz	30s/90°	2-point SPST	Cable	8	0,48	
20126	4930-K	230 VAC 50 Hz	30s/90°	2-point SPST	Cable	8	0,48	
20127	4950-K	230 VAC 50 Hz	60s/180°	2-point SPST	Cable	8	0,48	

Installation examples

Actuator 4930 with FBV 200C valve installation example

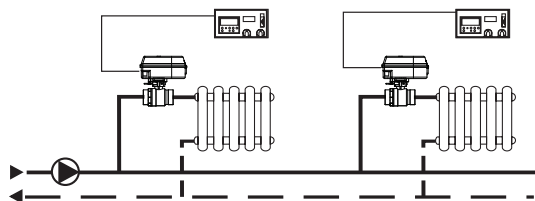

Actuator 4230 with FBV 600 valve installation example

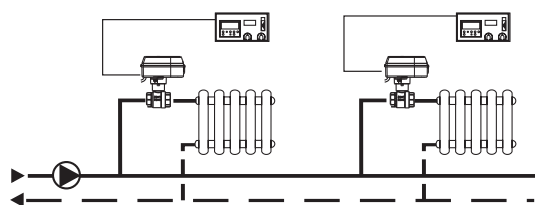

Actuator 4950 with FBV 230C-L valve installation example

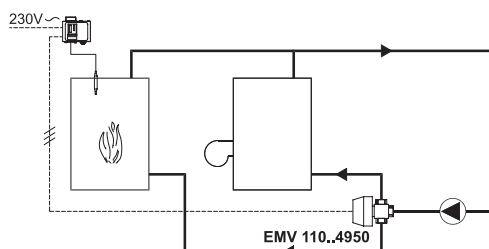

Features and options

- **Power supply:** 230V AC 50Hz / 24V AC 50 Hz
- **Solar/cooling adapter:** Heat barrier for protection of the actuator in solar or cooling systems.
- **Output signal (L):** at end position.
- **Adapter kits:** Clip system / Flexible holder system

Explode view:

1. Flexible holder system

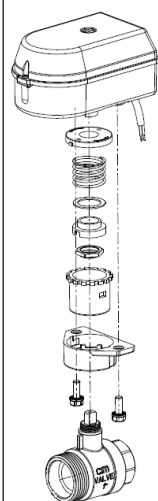

2. Clip system

(4930 with 200C) (4950 with 230C-L)

