

ROTODIVERT-M

FIRŠT ELECTRIC ACTUATORS EMV 110

with Quick fit system for 3-way rotary valves

FIRŠT®

2-POINT CONTROL	1 / 0	STOP AT END POSITIONS
-----------------	-------	-----------------------



FIRŠT actuators EMV 110, series ROTODIVERT-M, are 2-point control actuators designed for operating 3-way rotary diverting valves with quick fit system (DN 15 - DN 32).

- The FIRŠT ROTODIVERT-M actuators have not defined (ND) direction of rotation (CW,CCW).
- Actuators are available with cable connection and manual control handle.
- Recommended for diverting applications.

OPERATION

ROTODIVERT-M is an electric motor actuator designed for operating rotary diverting valves. Actuators are controlled by 2-point signal (SPST) with built-in relay module. FIRŠT ROTODIVERT-M actuators allow high regulating accuracy and easy installation with quick fit system.

Actuators are available in 230V AC 50 Hz and 24V AC 50Hz and are supplied with a 1m attached connection cable. Actuator can be manually operated with handle and button on the cover. Actuator can be optionally fixed to the valve with additional screw.

Actuators ROTODIVERT-M (18s/90°) are recommended for diverting applications with FDV 230 rotary valves from DN15 to DN32.

Anti blocking function provides that in case of blockade the motor changes its direction. Because of that feature, the motor is able to save itself from stopping.

MAINTENANCE

Actuator requires no maintenance. The installation of suitable strainer is recommended.

INSTALLATION POSITION

Actuator can be rotated on the valve body to fit different installation layouts and flow directions A-AB, B-AB, AB-A and AB-B.

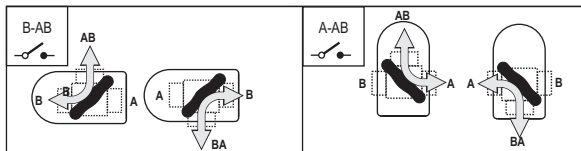

B-AB and A-AB installation layout.

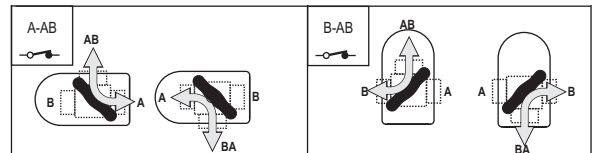

A-AB and B-AB installation layout.

ELECTRICAL CONNECTION

2-point control

Output signal at end position (B-AB).

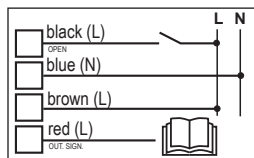

APPLICATION

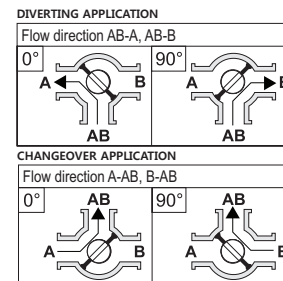

SUITABLE VALVES



Available as diverting/changeover unit:
ROTODIVERT-M

QUICK FIT SYSTEM

Compact design of the valve allows easy tool access when assembling and disassembling the valve. Quick fit system allows easy installation of the actuator on the valve body.



CE In accordance with PED, LVD, RoHS2, EMC

FIRŠT®

FIRŠT d.o.o.
Koroška cesta 56
SI-3320 Velenje
SLOVENIA

phone: +386 3 898 35 00
fax: +386 3 898 35 35
email: info@first.si
web: www.first.si

www.first.si
Let Firšt be your first choice.



ROTODIVERT-M

FIRŠT ELECTRIC ACTUATORS EMV 110

with Quick fit system for 3 way valves

Actuator with manual control handle (90° rotation) - 4380

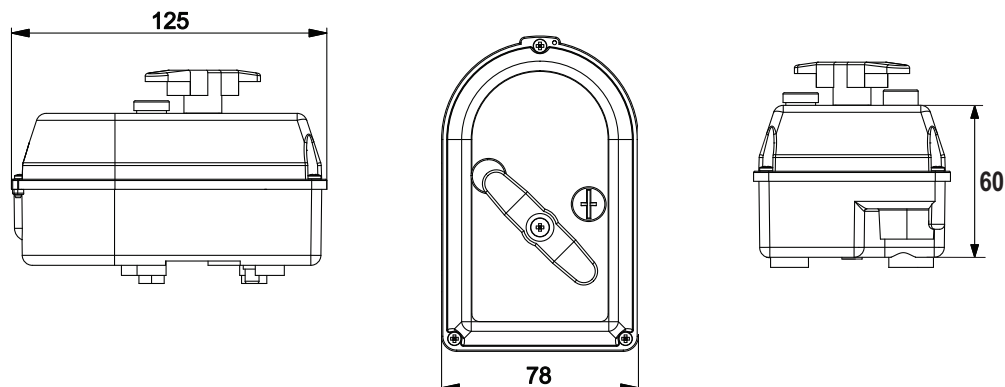

ROTODIVERT-M, for 3-way rotary diverting valves (90° rotation)

Code	Type	Voltage	Rotation time	Control signal	Connection	Max. torque [Nm]	Weight [kg]	Price (€)
10394	EMV110..4380 Rotodivert-M	230 VAC 50 Hz	18s/90°	2-point SPST	Cable	8	0,42	
10408	EMV110..4383 Rotodivert-M	24 VAC 50 Hz	18s/90°	2-point SPST	Cable	8	0,42	

Installation examples

FDV 230 installation example.

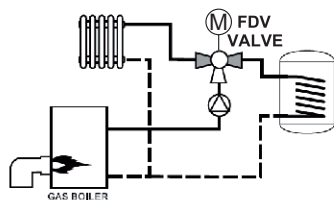

Diverting application

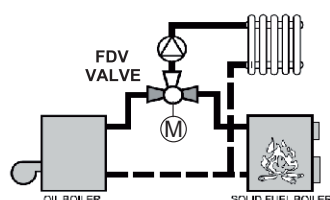

Changeover application

Features and options

- Power supply: 230V 50Hz or 24V 50Hz
- Output signal (L): at end position.